

HELICAL GEARS - 45° HELIX ANGLE

**64 NORMAL PITCH
.187 FACE
.1873 BORE**

20° PRESSURE ANGLE, AGMA Quality 10

RIGHT OR LEFT HAND

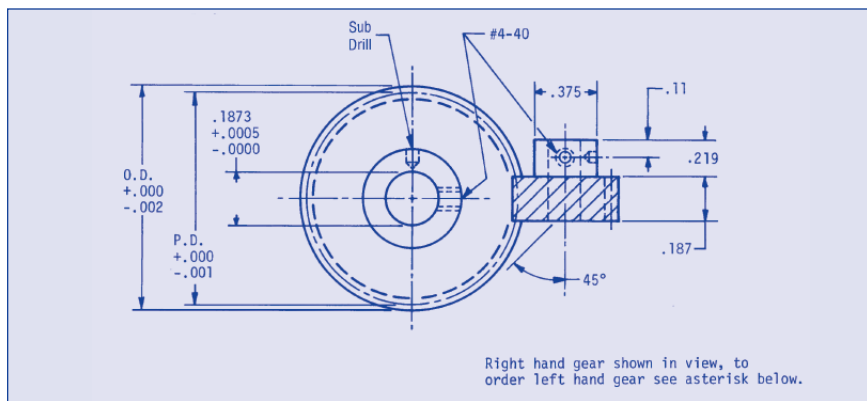

Material: 303 Stainless Steel
2024-T4 Aluminum – Anodized before gear cutting.

ORDER BY CATALOG NUMBER

303 STAINLESS STEEL	2024 T4-ALUMINUM Anodized before cutting	GEAR DATA		
Right Hand * Catalog Number	Right Hand * Catalog Number	Number of Teeth	Pitch Diameter	Outside Diameter
LKS-F3-20	LKA-F3-20	20	.4419	.473
LKS-F3-25	LKA-F3-25	25	.5524	.583
LKS-F3-30	LKA-F3-30	30	.6629	.694
LKS-F3-35	LKA-F3-35	35	.7733	.804
LKS-F3-40	LKA-F3-40	40	.8838	.915
LKS-F3-45	LKA-F3-45	45	.9943	1.025
LKS-F3-50	LKA-F3-50	50	1.1048	1.136
LKS-F3-60	LKA-F3-60	60	1.3257	1.357
LKS-F3-70	LKA-F3-70	70	1.5466	1.577
LKS-F3-80	LKA-F3-80	80	1.7676	1.799
LKS-F3-90	LKA-F3-90	90	1.9886	2.020
LKS-F3-100	LKA-F3-100	100	2.2096	2.241

*To order left hand type gears use – F4 in place of – F3 in catalog number.

Example: LKA-F4-20 = Left Hand (Aluminum)
LKA-F3-20 = Right Hand (Aluminum)

For unlisted numbers of teeth, pitch, special blanks, material or helix angle, please inquire for price.